

· GH ·

CRANES & COMPONENTS

CONTENTS

5

BEINGH	5
Origins	6
Evolution	8
Size of the GH group	10

12

EMPOWERINGH	12
Products	14
GH Global Service	28
Sectors	30

32

APPROACHINGH	32
Global presence	34
Customer portal	36

38

THINKINGH	38
GH 4.0	40

42

FELLOW TRAVELLERS	42
Customers	43

YESTERDAY, WE THOUGHT
ABOUT HOW TO MAKE **BETTER
LIFTING PRODUCTS.**

TODAY, WE DEVELOP **CRANES
THAT THINK.**

WE HAVE GONE FROM
PRODUCING MACHINES
TO CREATING **SMART CRANES**



94380

GH



BEING **GH**

WE ARE MORE
THAN A CRANE
COMPANY.

WE LIVE AND FEEL
GH.





GH UPHOLDS THE PILLARS
OF ITS FOUNDERS:
HONESTY AND GOOD WORK



OUR ORIGINS

In the middle of the last century, driven by the needs of a society that was recovering from its own contradictions, four brothers set up a family business to meet their survival needs and with the healthy ambition to build a project, with people at the centre of everything they did. **65 years and 125 000 cranes later, we are still the same.**

Our company stands firm by the guiding principles of its founders, based on integrity, work well done and the desire to pass on value to our customers.

Now **GH** is a leading company in the field of lifting, with innovative products and customers who are leaders in five continents, and still continuously evolving to adapt to the new demands and technologies that make us more global, accessible and competitive.

OUR OWN HOISTS

65 YEARS

WE ARE LEADERS IN THE MANUFACTURE OF HOISTS THAT MEET THE NEEDS OF THE MOST DEMANDING CUSTOMERS

Our evolution has meant flexibility and continuously adapting to new technologies, with a constant desire for improvement through innovation.

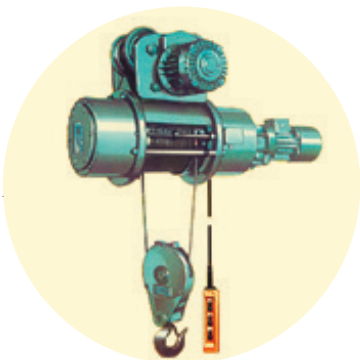

1960

Motor inside the drum with independent gearmotor for reduced speed through clutch.



1980

NF Double Girder hoist with external motor.

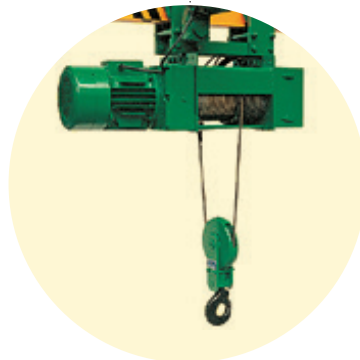

1990

Coaxial hoist with direct drive.



2000

Generation of single girder hoists with low headroom.

WE BEGAN
65 YEARS AGO AND OUR AMBITION IS
TO CONTINUE FOR ANOTHER 65 YEARS

WE DEVELOP A REMOTE SERVICE SYSTEM FOR ALL OUR CRANES: COREBOX

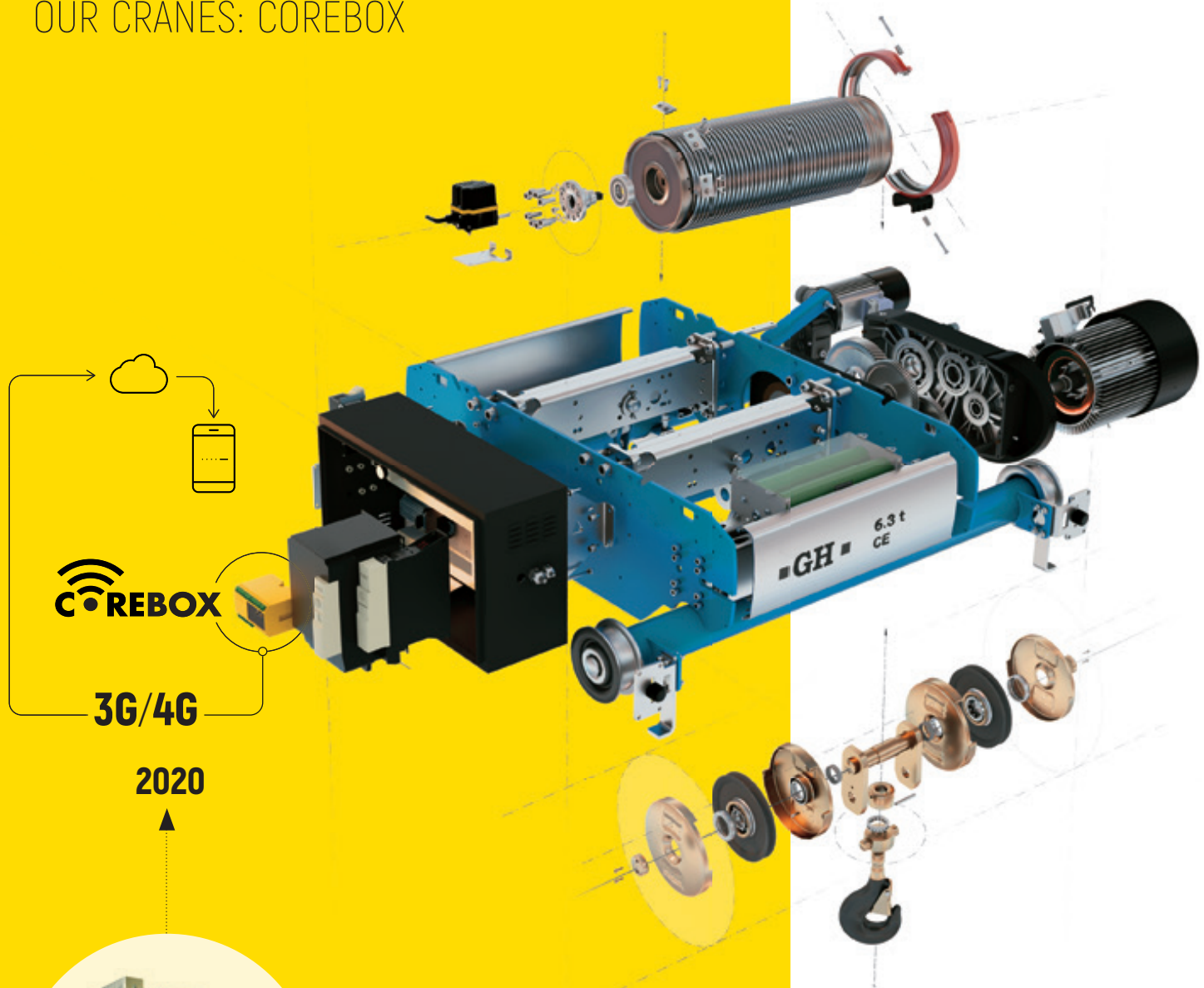

COREBOX

3G/4G

2020

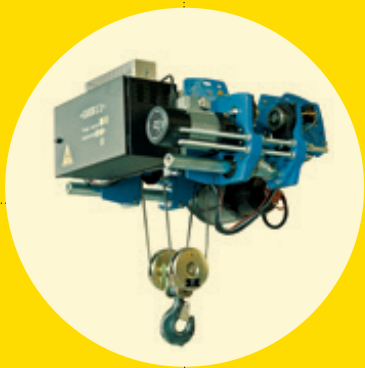

2005

New "C-shaped" design to optimise sizing.

2012

Incorporation of standard drives in the entire range.

MAINTENANCE SERVICE AND CONTINUOUS AND PERSONALISED CONTACT WITH THE CUSTOMER

Warn about incorrect use

Advise about possible failures

Analysis of productivity and efficacy data

WE ARE A TEAM OF MORE THAN 1000 PEOPLE AROUND THE WORLD

We are a business group with presence in the five continents. With qualified people from diverse backgrounds. And with a profile that clearly identifies us: comprehensive manufacturers of all our products and components, and with control of all the processes involved in both the manufacture and the service.

+125 000

CRANES SOLD WORLDWIDE

IN EVER MORE LOCATIONS, GETTING CLOSER TO OUR CUSTOMERS

We have different production and service centres to serve our customers around **the world**. We also have a commercial presence in **more than 70 countries on 5 continents**.

| EUROPE | Germany · Austria · Belgium · Bulgaria · Denmark · Slovakia · Slovenia · Estonia · Finland · Spain · France · Greece · Hungary · Ireland · Italy · Lithuania · Luxembourg · Norway · Netherlands · Poland · Portugal · United Kingdom · Czech Republic · Romania · Sweden · Switzerland · Turkey **| AMERICA |** Argentina · Brazil · Bolivia · Canada · Chile · Colombia · Costa Rica · Cuba · Ecuador · El Salvador · USA · Peru · Guatemala · Honduras · Nicaragua · Panama · Paraguay · Mexico · Dominican Republic · Uruguay · Venezuela **| ASIA |** Armenia · Korea · China · Hong Kong · India · Indonesia · Kazakhstan · Kuwait · Malaysia · Pakistan · Singapore · Thailand · Tajikistan · Turkmenistan · Uzbekistan · Vietnam **| MIDDLE EAST & AFRICA |** Angola · Saudi Arabia · Algeria · United Arab Emirates · Egypt · Iraq · Israel · Jordan · Morocco · Nigeria · South Africa · Tunisia **| OCEANIA |** Australia · New Zealand



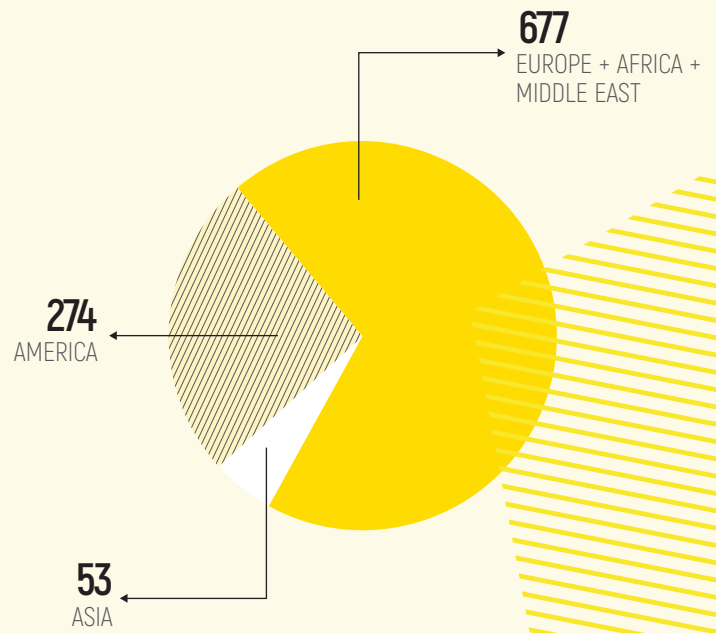
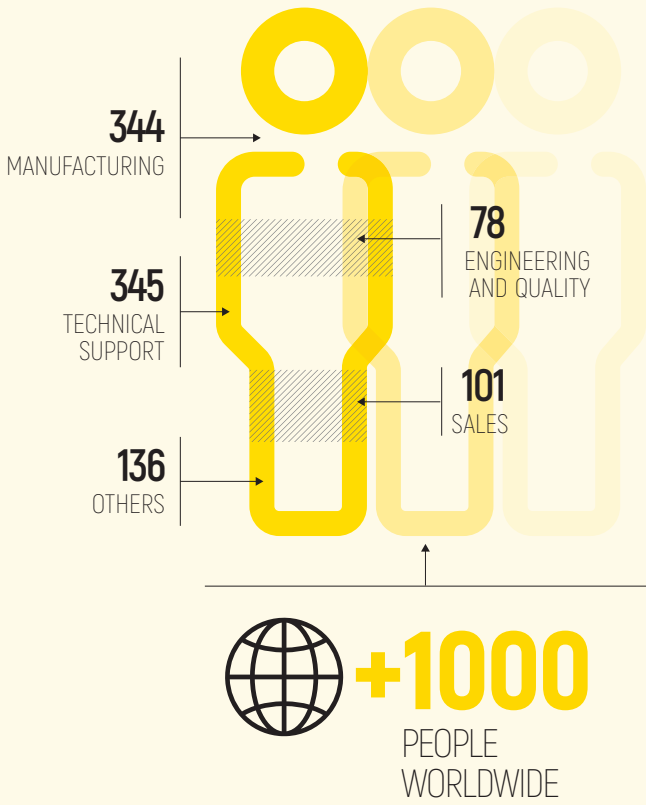

10 **MANUFACTURING PLANTS** IN THE STRATEGIC MARKETS



DIRECT PRESENCE WITH OUR OWN COMMERCIAL SUBSIDIARY IN 15 COUNTRIES

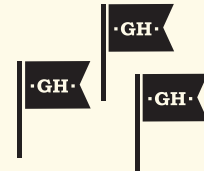

COMMERCIAL PRESENCE IN MORE THAN **70 COUNTRIES** WITH OUR LOCAL COLLABORATORS

IN THE **TOP 5** CATEGORY

OF **CRANE MANUFACTURERS** WORLDWIDE



WE ARE **MARKET LEADERS** IN PORTUGAL AND SPAIN



WE CAN PROVIDE SOLUTIONS **IN ANY PART OF THE WORLD**



-GH-

CE 2017

-GH-

CE 2010
N°94606

-GH-

-GH-

-GH-

15/15t 0

The background of the image is a low-angle shot of a large industrial factory interior. The ceiling is high, with a complex network of white metal beams and pipes. Several bright yellow overhead cranes are visible, extending across the width of the frame. The lighting is bright, likely from skylights or large industrial lamps, creating a clean and modern atmosphere. A large, solid yellow rectangular area is overlaid on the right side of the image, containing the text.

EMPOWERING**GH**

WE ARE SELF-SUFFICIENT
MANUFACTURERS.
HOW DO WE DO IT?

BY EXERCISING
CONTROL OVER THE
WHOLE PROCESS.

GH

—

CRANE COMPONENTS

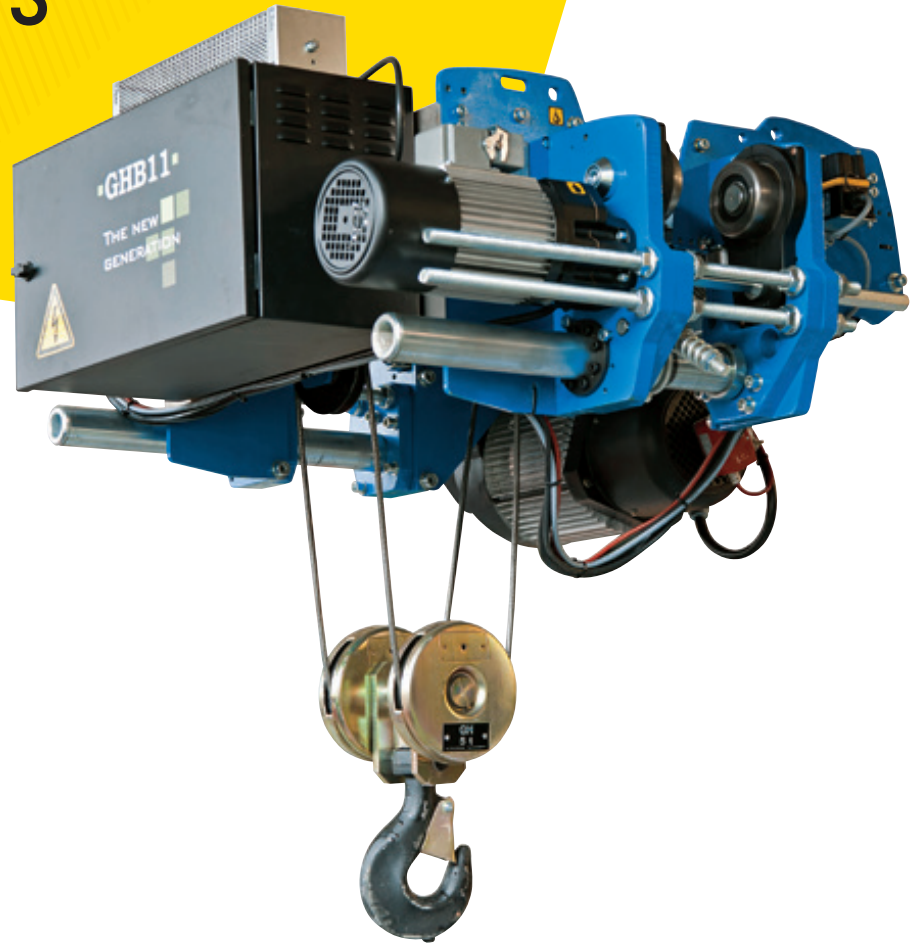

HOISTS

STANDARDISATION
OF LE SPEED DRIVE

CABINETS WITH COREBOX,
DATALOGGER AND CONNECTIVITY

The **GH** hoists are made using the most modern design technologies. Their manufacture is carried out with the most sophisticated means of production and the appropriate organisation.

GH wire rope hoists for bridge cranes, gantry and semi-gantry cranes, single and double girder, and other types of application. With capacities from 800 kg to 120 t in foot mounted and single and double girder versions. Robust and compact, modular construction and easy maintenance, with different wire rope falls, allows a wide range of hook paths, lifting speeds and **FEM / ISO** work groups depending on the requirements in terms of starts per hour and duty cycles for the loads to be lifted.

The **GH** hoists incorporate the control system and monitoring of the Safe Operation Period as standard.

The range of **GH** hoists has been designed based on the principles of reliability, safety, durability, competitive price, easy maintenance and, of course, availability.

HOISTS

FROM 800 KG
UP TO 120 T

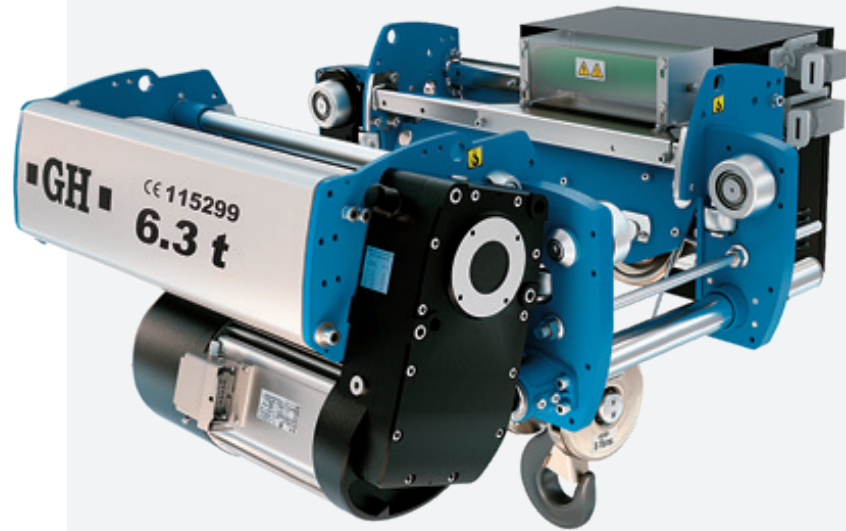

1

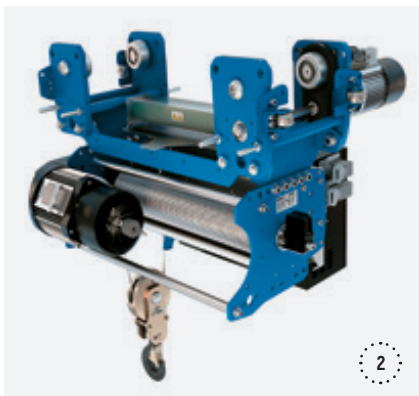

2



3



4



5



6



7

1. GHA12 HOIST
Low headroom

2. GHB11 SINGLE
GIRDER HOIST

3. GHD13 HOIST
Normal Headroom/
for curves

4. GHB11 HOIST
Foot mounted
Execution 1/1

5. GHD13 HOIST
Tubular double
girder

6. GHD13 HOIST Double
girder on end
carriages

7. CABINET WITH
REGENERATIVE MODULE
FOR GHB11 HOIST

CRANE KIT

The **Crane Kits**, with both standardised and special components, allow the easy construction of top running or underslung EOT cranes, as well as Gantries and Semi Gantries.

They allow cranes to be manufactured with just the beams being available. They are supplied with the project design and all the crane components and accessories, including the electrical equipment.

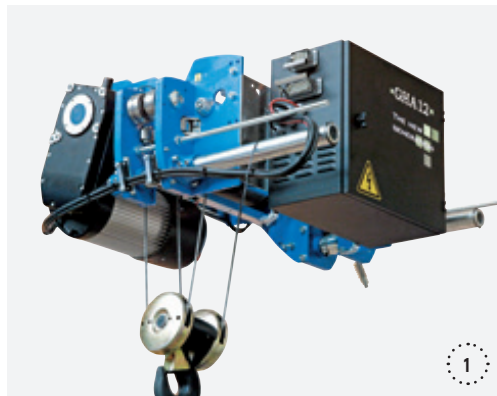
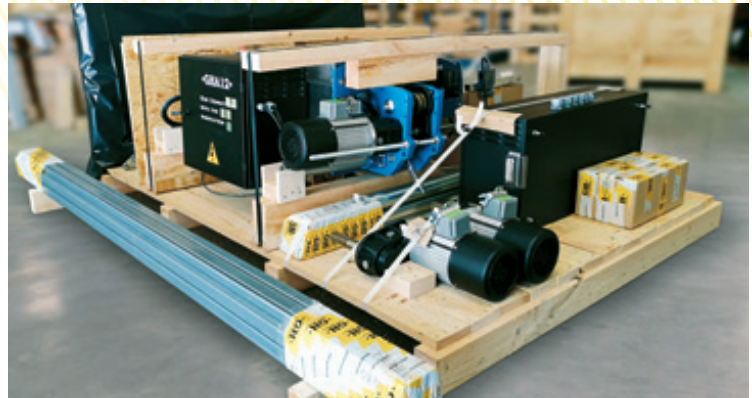

1.
HOIST

2.
END CARRIAGES



3.
GEARED MOTOR
FOR TRAVEL

4.
ELECTRICAL
CABINET

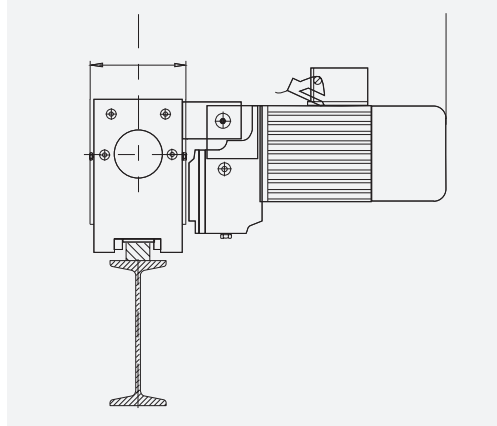

5.
FESTOON
FOR CRANE



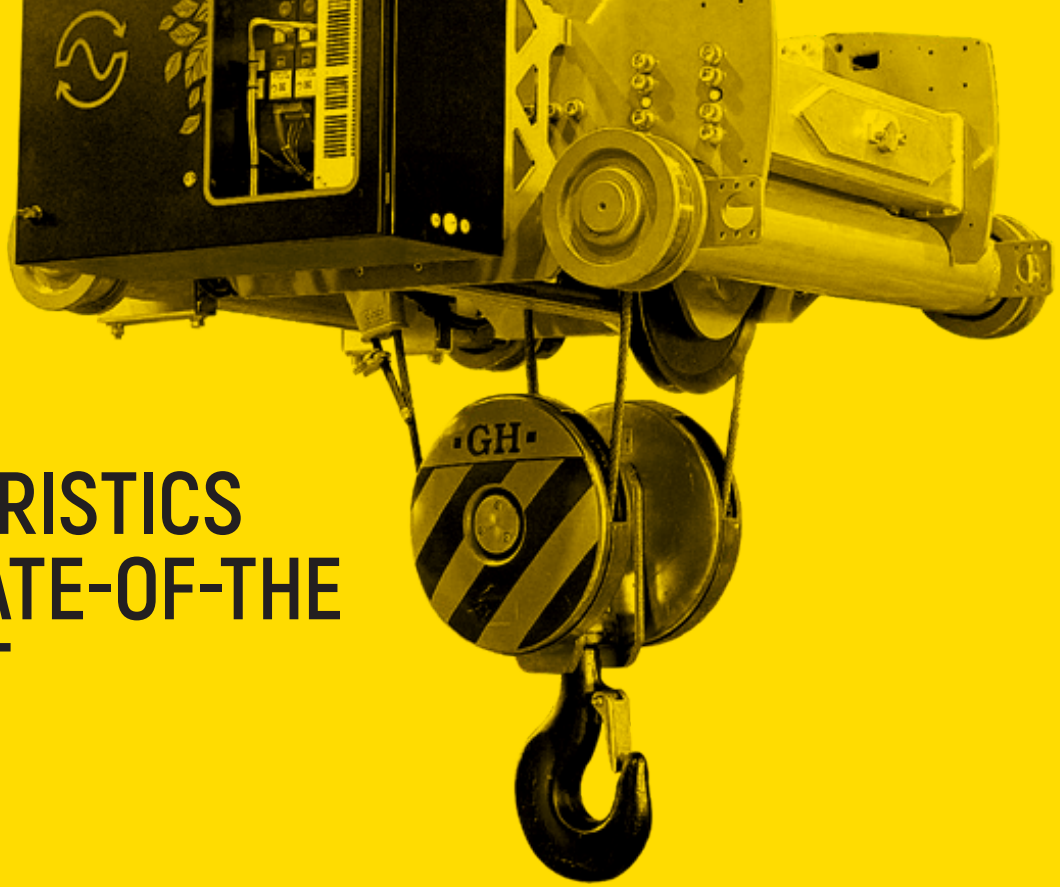

CHARACTERISTICS OF THE STATE-OF-THE- -ART HOIST

1

Design: robust, compact and clean with a modern and technological profile.

No counterweights: lighter and with the most economical structure.

Modular design: changing just a few of the parts allows the hoist configuration to be transformed.

Bolted structure: The maintenance is simpler and avoids the deformation of the welded frame, achieving greater versatility.

Exterior fairing GHA12, GHB11 and GHD13, with a common plate for the entire range of each generation.

Compact tubular double girder concept: More competitive solution than the typical trolley with end carriage on the market. Exclusive to GH.

2

Gears made of rectified cemented material. This lengthens the life of the gearbox, manufactured according to ISO 6336. Reduces vibrations and noise of the gearbox.

Protection of travel gear in suspended low headroom: avoids handling and possible entrapment. Prevents the dripping of grease.

Four-gauge pin type load cell: for load limiter, which makes it possible to know the load spectrum and determine the SWP.

Steel wire rope, with coated steel core and safety factor greater than 5 in all configurations.

Quick connectors which facilitate maintenance and save assembly time.

Cabinets with COREBOX, datalogger and connectivity.

Top of the range commercial electrical components: Schneider, Weidmüller, etc.

3

Standardisation of variable speed drive for all movements.

Increased safety: by placing the encoder in lifting that favours the return of the command information from the drive to the motor. Robust and high-resolution design encoder.

High-capacity braking resistance, overload capacity, oversized. High dielectric strength.

Overspeed for small loads: Allows the hoist to go faster if the load is below 25%. With the maximum load it can go at nominal speed. From 25% to 60% maximum overspeed.

Possibility of fitting regenerative drive and the elimination of braking resistors. Energy savings.



GH EXTRAS TO MANUFACTURE EVEN MORE EXTRAORDINARY MACHINES

The GH hoists and cranes have drive control by means of frequency inverters as standard.

The incorporation of regenerative modules enables us to provide great advantages for our customers in large machines.

STANDARD GH HOIST WITH REGENERATIVE DRIVE

COREBOX



Committed to technologies derived from industry **4.0** applied to the crane and its interaction with people.



Standard solution for the **remote monitoring** of lifting equipment.



Connectivity via **3G/4G, Wi-Fi and USB.**



User access **via the cloud** to monitor the status of the crane.

CORE+



Plug & play solution to add **automation functionality** to the cranes.



Synchronism in lifting and crosstravelling **Reduces load sway** without additional sensors.



Connectivity via **3G/4G or USB.**



Allows monitoring of the status of **alarms and consumption.**



ENERGY SAVINGS



ENVIRONMENTAL SUSTAINABILITY



CUSTOMER COST SAVINGS



REGENERATIVE VARIATOR

The incorporation of regenerative modules gives our equipment great advantages for our customers. Energy savings, environmental sustainability and customer cost savings



CENTRIFUGAL BRAKE

Autonomously operating system with a mechanical device that takes advantage of the centrifugal force generated when the load is falling. The centrifugal brake is mechanically coupled to the drum of the hoist by means of a pinion (brake) – crown (drum) system.



TWIN HOIST

Synchronised lifting of up to 200t. with **CORE+**. The **TWIN HOIST** solution minimises stresses in the mechanical components and structures, controlling the starting and stopping of the drives through frequency converters.

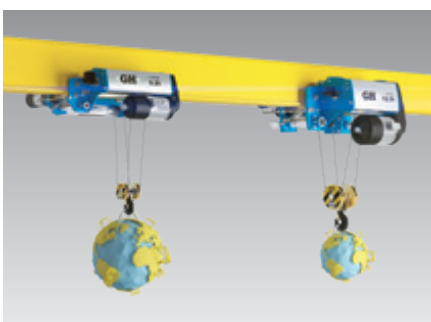

CORE+ SYNCHRO

CORE+ SYNCHRO Easier and safer handling of large loads using 2 hoists (of same or different capacity), operating in same crane. Hassle-free for operator as it maintains relative positions automatically between hooks, both horizontally and vertically.



CORE+ STABILITY

CORE+ STABILITY material-handling system that ensures enhanced load stability at higher speeds. Ensures smooth acceleration and minimal load sway and enhances safety with drastically reduced chances of damage and injury.



INCOTANDEM

INCOTANDEM allows synchronisation of two cranes working in tandem with effective synchronisation of their movements. Control the movements of 2 cranes from 1 radio control occupying fewer radio frequencies (only 3 frequencies per pair of cranes).

BRIDGE CRANES

These have a robust construction and a high level of standardisation. Very modular and adaptable to any need, with very reliable components and available for a wide range of applications.

The structure is a box beam or commercial section, optimised by computer-aided calculation processes.

Our designs offer the best technical-mechanical option with the best value for money.

The optimised combination of the crane structures with the mechanical equipment for lifting, cross travelling and long travelling, allow the best hook approaches for optimising space and the best use of spaces.

The construction of the structural welded components, with automated and robotic systems, always guarantees the correct repetition of the welding processes and a high quality product.

The mechanisms used in our industrial bridge cranes are an indivisible part of the cranes, taking in the entire range from chain hoists of 500 kg to wire rope hoists of 200 t and open winches up to 400 t.

ROBUST AND HIGH LEVEL OF STANDARDISATION



Top running Single Girder crane



Double girder crane and cantilever crane



Suspended crane

GANTRIES AND SEMI-GANTRIES

—
Up to 400 t.



GH is a European leader in the design and manufacture of gantry cranes with a large number and variety of applications. Due to the number of gantry cranes installed, **GH** is a leader for this type of machinery.

GH adapts the manufacture of its gantry cranes to the needs and circumstances of each customer, always taking into account the type of work to be carried out and load to be handled.

The experience acquired since 1958 backs us up as specialists in gantry and semi-gantry cranes.



MOTORISED TROLLEYS

From 10 t up to 200 t.



The **GH** transfer carts allow the movement of loads at ground level in all types of industries and applications.

They are robust, have a modular construction and are available in a wide range of products and adaptable to any need.

They are equipped with all the necessary safety features for the movement of machines at ground level.

They are an important complement to the cranes for the movement of heavy loads at ground level, being an ideal solution for the transfer of loads between adjacent buildings.

THERE ARE TWO MAIN TYPES OF TRANSFER CARTS, WITH DIFFERENCES IN THE TYPE OF MOVEMENT:

Steerable transfer carts:

These can move freely.
Available in battery-powered version.

Transfer carts on rails:

These move only in a straight line.
Available in battery or power supply versions, by means of a cable reel or power supply line.

**IDEAL SOLUTION FOR THE
TRANSFER OF LOADS BETWEEN
ADJACENT BUILDINGS**

PROCESS CRANES OPEN WINCH

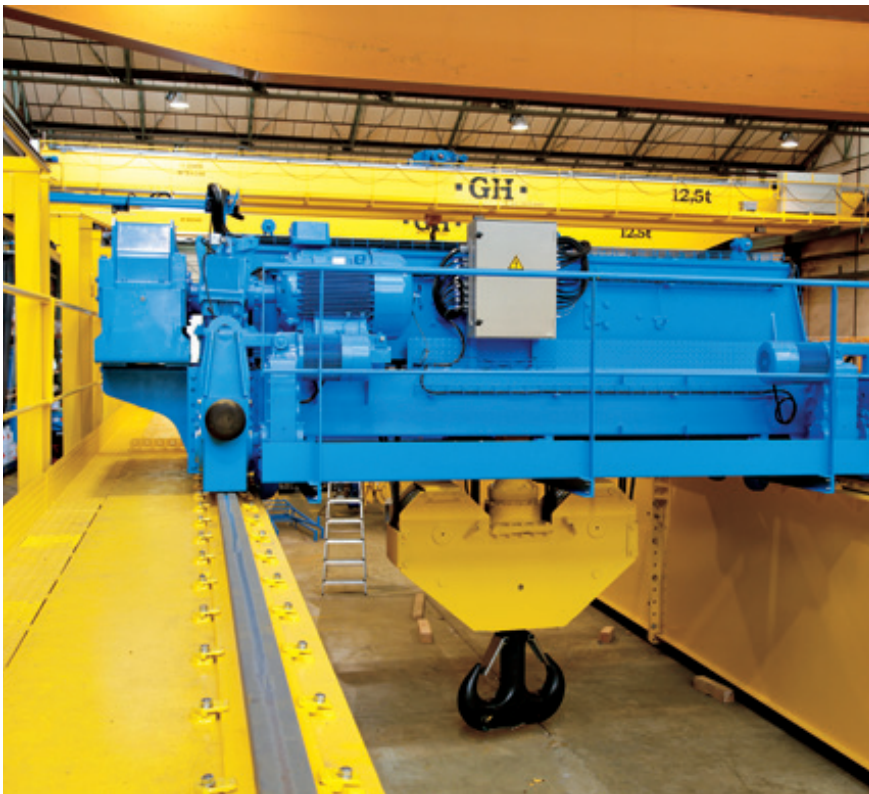

We design special solutions for non-standard lifting mechanisms based on applications or work environments.

MAIN CHARACTERISTICS ARE:

Higher lifting capacities and/or higher lifting speeds and/or higher FEM groups.

The use of commercial motors allows adaptation to customers' standards. 1 motor, instead of applications with a hoist that need 2 motors for the same lifting capacity and therefore double the probability of equipment failure. Possibility of working with motors of 1,500 and 1,000 rpm. Greater sizing of the motor.

Motor-gearbox and gearbox-drum connections use intermediate flexible couplings.

True vertical lift without side displacement of the hook during the lifting operation.

Greater accessibility for maintenance of the different components.

The brake is completely external, improving its accessibility and adjustment.

The gearbox has a top opening lid facilitating access, maintenance and inspection.

Anti-overlapping and slack wire rope detector. The anti-overlapping system is formed by a support and a mechanism with springs fastened with screws, to prevent the cable from leaving the slots of the drum.

AUTOMOTIVE GANTRIES

Up to 600 t.

The **GH** automotive gantry cranes on rubber tyres allow the autonomous movement of loads in all types of industries and applications.

At **GH** we have a wide variety of automotive gantry cranes, handling loads ranging from 20 to 600 t, offering efficiency in outdoor yard movements for nautical and industrial sectors. All of them are characterised by their great robustness, simplicity of use, easy maintenance and manoeuvrability, and they are particularly useful for sectors involving prefabricated components and external logistics warehouses (wind power, precast concrete, heavy sheet metal working, container cranes, etc.).



FLEXIBLE, FAST,
AND MANEUVERABLE

HEAVY-DUTY, ROBUST,
AND RELIABLE

SAFE

CUSTOMIZED

LOW CONSUMPTION





e·MOTION

GH presents its jump into clean energy for its automotive RTGs by introducing GH70e, a full electric boat hoist with 65t capacity. A high performance ion-lithium battery pack with 10 years warranty provides a full working day of

independent operation and its fast charger aids its recharge. GH is committed to sustainability, incorporating an optional independent solar panel support system that provides up to 20% of the daily energy used.

**FULL-ELECTRIC
SERIES
NO EMISSIONS. NO LEAKS**

- / **Able to incorporate a variable span system that improves dry-docking efficiency for boats with different widths.**
- / **Electronic steering offers complete maneuvering versatility.**

JIB CRANES

From 500 kg up to 20 t.



WALL JIB CRANE

For the handling of lightweight parts during production processes.

COLUMN JIB CRANE

For the handling of light and medium weight parts during production processes where independent manufacturing stations are required with respect to the main cranes in a factory building.

INDUSTRIAL JIB CRANE

For the handling of heavy loads during production processes and industrial activities where independent manufacturing stations are required with respect to the main cranes in a factory building.

PORT JIB CRANE

Also known as Marine Jib Cranes, they are specially designed for lifting heavy loads in port environments.

An ideal solution for the movement of loads in a circular area near the manufacturing station.

With chain and wire rope hoist options, in low headroom or suspended type.

Great precision of movement with manual or motorised versions.

The industrial jib cranes, from 500 kg up to 20 t, allow cantilevers suitable for each type of application.



Port jib crane
Industrial jib crane

DRY DOCKS

Up to 4 t.

OPTIMISING SPACE USAGE AT A BOATYARD

We design and manufacture rail-mounted gantry cranes for dry docks that are adapted to each customer's specific space and needs, optimising use of the space and expanding docking capacity to get the most out of the boatyard.



AUTOMATED SERVICE

Industry developments allow us to design cutting-edge solutions, offering automated dry dock services to facilitate boat docking, storage and delivery to expand a boatyard's service to reach its full potential.

STREAMLINED DELIVERY OF BOATS

Our dry docks are designed to provide customers with the best service, so that they can have their boats ready in just a few minutes through automatic or semi-automatic operations.

PRESERVATION OF BOATS ON DRY DOCK

Boats are not in contact with the water, improving preservation and safety.

WE ADAPT TO EACH MARKET AND CUSTOMER, WITHOUT ANY REDUCTION IN QUALITY OR PERFORMANCE. GH GLOBAL SERVICE.
A 10 OUT OF 10 SERVICE

Wherever our customer is, they can be sure of a quick and effective response. We provide a Technical Support Service in the 5 continents. With advanced technology and continuous advice.

- 1 Comprehensive preventive maintenance.
- 2 Corrective maintenance.
- 3 Supply of spare parts.
- 4 Supply of lifting accessories.
- 5 Modernisations and renovations.
- 6 Training of crane operators.
- 7 Assembly and commissioning of cranes.
- 8 Standard crane warranty service.
- 9 Service technology.
- 10 Connectivity / machine / technician / customer.

REFURBISHMENT AND UPGRADES



CLOSE AT HAND FOR EVERY CUSTOMER



EXTENDING THE LIFETIME OF THE MACHINE

IMPROVING PERFORMANCE AND SAFETY

Modernisation services extend the useful lifetime of an equipment, adapting it to the new needs and improving its safety.

Thanks to our experience and technological know-how, we can handle all kinds of crane modernisation projects, both for **GH** branded cranes and others.

TRAINING OF OPERATORS

The correct use of our machines requires well-trained operators so that they follow the required standards of maximum safety and efficiency.

We have an operator training protocol that is carefully structured and documented, taught by our training experts.



SPARE PARTS

GH PARTS & ACCESSORIES is our main warehouse in Madrid-Spain, which supplies the highest quality spare parts to regional service centres around the world, in a very short period of time.

Purchasing the spare part from the Official **GH** Service Network assures you that it is original and comes with the manufacturer's warranty.



ACCESSORIES FOR LIFTING

Hoists, magnets, rockers, claws, clamps, weighing, slings and chains, lifelines, lightweight systems, power supplies, radio controls, lightweight jib cranes and chain hoists.



CONNECTIVITY

This is the technology that connects directly to service technicians, customers, machines and the GH data centre, through the cloud. It shows our customers all the service and operating data of our machines.

GH, through its data centre, can then perform Big Data analysis to better understand the operating patterns of our machines, developing products and services according to the production needs of our customers.



SECTORS

We create particular solutions for specific sectors. We offer the optimal solution to every need. With the experience accumulated since 1958, our extensive capabilities and our own engineering.

At **GH** we know that each customer has specific preferences and need, therefore, we are prepared to develop machines that are fully adapted to each business.

- [Aeronautics](#)
- [Automotive](#)
- [Renewable energies](#)
- [Public works](#)
- [Iron and steel](#)
- [Sheet metal working](#)
- [Foundry](#)
- [Steel handling](#)
- [Waste Treatment](#)
- [Paper Mills](#)
- [Container Handling](#)
- [Precast Concrete](#)
- [Nautical](#)
- [Shipyards](#)
- [Railway](#)
- [Stone handling](#)
- [Mining](#)
- [Others](#)



**WE DEVELOP CRANES
AND COMPONENTS FOR
ALL TYPES
OF INDUSTRIES AND
APPLICATIONS, AND
FOR EACH WORK
ENVIRONMENT**







APPROACHING**GH**

WE GUARANTEE
A FAST, EFFICIENT
AND PRECISE RESPONSE,
AT ALL TIMES AND
ANYWHERE IN THE WORLD.

HOW?

WE ARE ALWAYS
CLOSE AT HAND

GLOBAL PRESENCE

THE EFFORT TO EXTEND OUR PRESENCE AND ACTIVITIES HAS MADE US INTO A MULTI-LOCATION COMPANY. **ALL OUR CUSTOMERS ARE GUARANTEED TO HAVE ACCESS TO A PROPER SERVICE THAT PROVIDES A RESPONSE TO THEIR NEEDS**

Our presence in the American continent with three production plants that extend strategically from North to South, makes us a leading brand.

Our factories in Southern and Central Europe put us in a great position to serve all European customers.

Our production plant in Thailand and our presence in China and India give us a magnificent base from which to serve the Asian market.

+125 000
Cranes sold

+1000
employees

Worldwide technical service

GH, Europe



Spain Beasain



Spain Olaberria



Spain Alsasua



Spain Bakaiku



Portugal São Mamede do Coronado



France Saint-Herblain



Poland Klobuck

GH, America

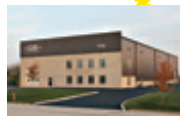

U.S. Illinois



U.S. Texas



Mexico Querétaro



Colombia Bogotá



Peru Lima



Brazil Cabreúva

GH, Asia



India Pune



Thailand Chonburi



China Shanghai



UAE Abu Dhabi



UAE Dubai

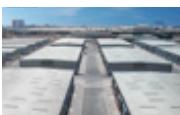

UAE Ras Al Khaima



Saudi Arabia Al Khobar

Lifting
your **world.**

THE POWER OF ADDING DIVERSE STRENGTHS



GH's presence in all these markets has given us the ability to combine different knowledge and cultures in order to adapt ourselves in line with the phrase that summarises our position with respect to international markets: "Think global, act local".

Our products, designed at the heart of the company, are the same in all markets, maintaining the same features in terms of safety, quality and capacity.

"THINK GLOBAL,
ACT LOCAL"

THE SYNTHESIS: THE CUSTOMER PORTAL

Our efforts are not only aimed at the value that we incorporate into the product.
Our whole philosophy revolves around two concepts:

PEOPLE AND THE CUSTOMER

These premises shape our way of acting.



On this website, GH-GS shows its customers all the service information and operational data via the cloud.



OPERATIONAL DATA



IN THIS PLATFORM WE BRING TOGETHER THE VERY LATEST COMMUNICATION TECHNOLOGY TO PROVIDE COMPREHENSIVE SERVICE MANAGEMENT THAT ALLOWS:

Online reporting of incidents for the crane.

The prevention of future problems that may affect production.

Rapid intervention in the event of uncontrollable incidents.

The availability of statistical information on the activity of the cranes so that the customer can make the appropriate decisions.

Simple, shared and secure administrative management for the customer and the service provider.

Telematic control of the crane's performance and incorrect actions in the handling of the cranes.

CORESOURCES

Document management

Contract Management

Issuing of warnings

Data record

COREINSIGHT

Indicators about the operating conditions

Proactive alarms about the operating conditions

RAM indicators and Reports

Technical advice

GH-GS APP

All our technicians work with this technology, where they record all the service data: fault codes, spare parts used, checklists, maintenance reports, technical documentation, etc.

+ GH-GS APP

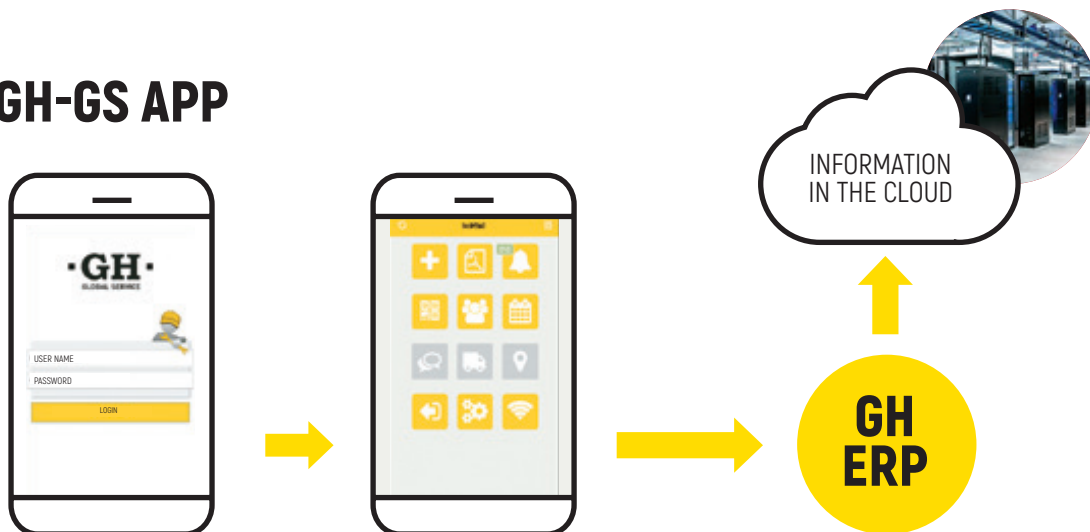

+ COREBOX

This is a datalogger that collects data and operating parameters from different crane devices.

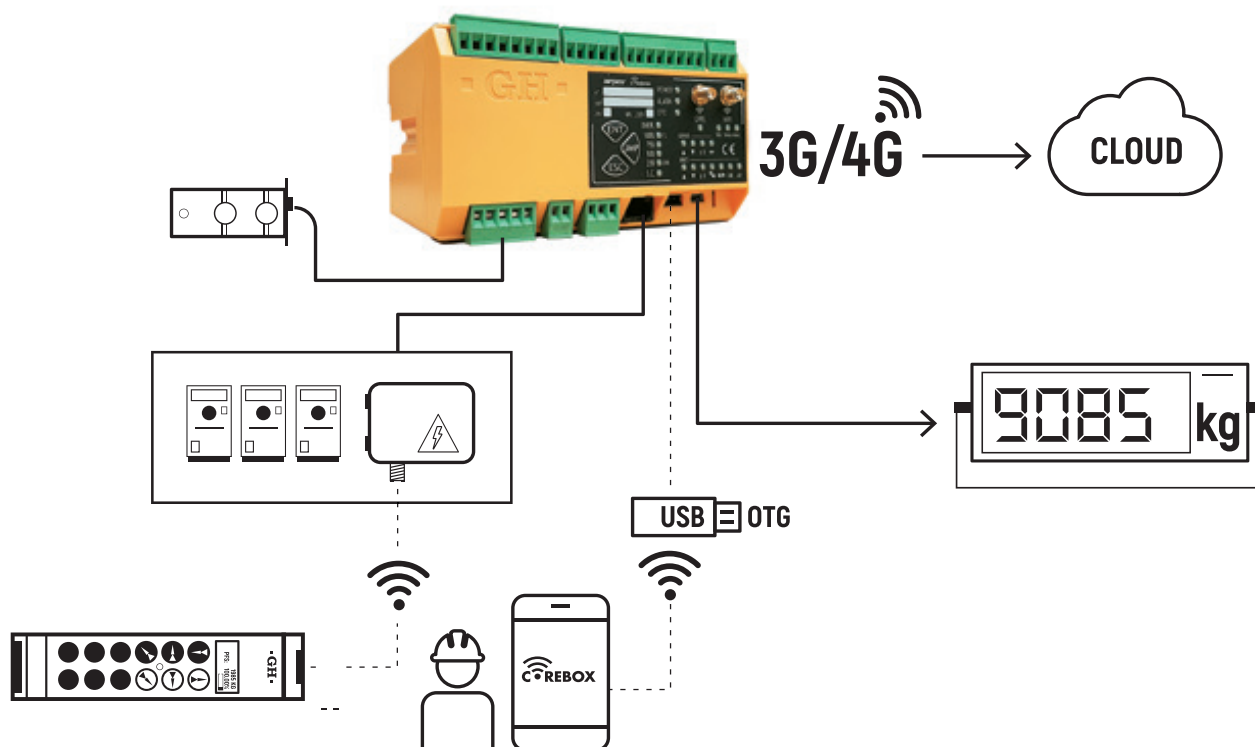



THINKING**H**

WE ARE MOVING
TOWARDS
THE SMART CRANE.
HOW?

WE INNOVATE
IN THE PRODUCT
AND THE SERVICE

—



CONSTANTLY MOVING TOWARDS THE SMART CRANE

The world of **industry 4.0** has made a strong entry into the world of cranes. GH has internalised this new scenario and makes constant investments with the aim of achieving greater digitisation, with a firm commitment to automation and a constant search for improvement in the field of the connection between companies and machines.

GH 4.0

1



Web configurator that allows us to provide a quote for a crane, anywhere in the world, at any time.

2



Top of the range calculation tools for structures and gears (KISS, ANSYS), 3D and 2D design tools (SolidWorks, AutoCAD).

3



Metrology laboratory: for the dimensional control of the parts we machine.



Lasertracker. For the dimensional control of the cranes we use a maximum precision laser machine.

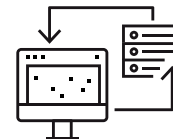

Monitoring in real time of the current status of the manufacturing process with data collection terminals in the plant.





4

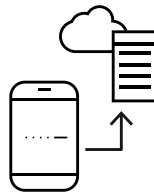

"Mobile Service" APP for the management of preventive, corrective and other maintenance activities for Service technicians, through which they receive notifications, fill in work reports and carry out other tasks, which reduces paper use to zero, and the information is available for GH and the customer instantly through the Customer Portal.



Customer portal: where customers can find the original crane documentation, as well as information associated with the repairs and maintenance of each crane.

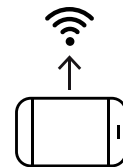

Remote monitoring of the operational data of the crane through the IoT Platform for the collection and processing in real time of the service data of our machines, which increases the possibility of predictive maintenance and enables more rapid corrective maintenance action.

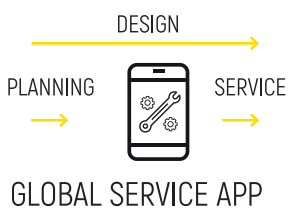

- Document management.
- Contract Management.
- Issuing of warnings.
- Data record.
- Indicators about the operating conditions.
- Proactive alarms about the operating conditions.
- RAM indicators and Reports.
- Technical Advice.



GH CLOUD



FELLOW TRAVELLERS

OUR CUSTOMERS
HAVE SHOWN US
THE WAY.

WE HAVE JUST
ACCOMPANIED THEM
ON THEIR JOURNEY

—

WHEN A **GH** CRANE LEAVES THE FACTORY, WE KNOW THAT IT WILL REACH GREAT HEIGHTS. THE SAME HEIGHTS AS OUR CUSTOMERS

- ACCIONA
- ACERINOX
- ACEROMEX
- ACEROS AREQUIPA
- AÇOTEL
- AERIS ENERGY
- AIRBUS
- AKE
- INFRASTRUCTURE
- ALSTOM
- AQUALIA
- ARCELORMITTAL
- AVIANCA
- BREMBO
- BUDIMEX
- CAF
- CATERPILLAR
- CEMENGAL
- CIE AUTOMOTIVE
- COBERMETAL
- CODEME
- COMANSA
- COPACHISA
- COSENTINO
- DANFOSS
- DANOBAT
- DIAMOND C
- TRAILERS
- DOOSAN
- ELECNR
- EMBRAER
- FAURECIA
- FIAT
- FINANZAUTO
- FCC
- FERROVIAL
- FUNDIFAS
- GAMESA
- GENERAL ELECTRIC
- GESTAMP
- GPI TANKS
- GUARDIAN GLASS
- HARBIN HAFEI
- AIRBUS COMPOSITE
- HEIMBACH
- HONGDU
- AVIATION
- HYUNDAI
- INDAR
- INTEGRITY
- TOOL & MOLD
- JIULI
- KOMATSU
- KONSORCJUM
- STALI
- LIEBHERR
- LLAXTA
- MAHINDRA
- METALS USA
- MOLDTECH
- MTU
- NAVANTIA
- NATIONAL OILWELL VARCO
- NISSAN
- NOVARES
- NORDEX
- PICHON
- POWER ELECTRONICS
- RENFE
- RELIABLE REBAR
- RSTEEL FÁBRICA DE TUBOS METÁLICOS
- SAICA
- SAKANA
- SAMASZ
- SEAT
- SERMEFIT
- SHIMIZU
- SHOUGANG
- SIAM CEMENT GROUP
- SIEMENS
- SOFIDEL
- STADLER RAIL
- STALPROFIL
- STECON
- TALGO
- TECNOARANDA
- VALE
- VOLVO
- WUTKOWSKI

COMMITMENT TO OUR CUSTOMERS



SPAIN**GH CRANES & COMPONENTS****CENTRAL OFFICE**

Apdo. 27 - B Salbatore
20200 Beasain (Gipuzkoa) Spain
T +34 943 805 660
F +34 943 888 721
ghcranes@ghcranes.com
www.ghcranes.com

GH GLOBAL SERVICE

Polígono Basozabal, 2
20212 Olaberria (Gipuzkoa) Spain
T +34 902 205 100
globalservice@ghcranes.com

**MECANIZADOS ALSASUA, S.L.
MACHINING CENTRE**

Polígono Ibarria, 37
31800 Altsasu (Navarra) Spain
T +34 948 467 625

**GH GUERRA MANUTENCIÓN
GUEMA, S.A.
CRANE MANUFACTURE**

Aiztiko Ind., 3
31810 Bakaiku (Navarra) Spain
T +34 948 562 611

BRAZIL**GH DO BRASIL
IND. E COM. LTDA.**

Acesso pela Rod. Dom Gabriel
P.B. Couto, Km 81
13313-000 Cabreuva, Brazil
T +55 1144090066
vendas@ghcranes.com.br

CHINA**GH (SHANGHAI)
LIFTING EQUIPMENT CO., LTD.**

Floor 7, No. 966, Huaxu
Road 201702 Qingpu District
(Shanghai) China
T +86 21 5988 7676
ghchina@ghcranes.com

COLOMBIA**GH COLOMBIA SAS**

Carrera 48 No 91-93 Castellana
Bogotá, Colombia
T +57 (1) 7504427
ventasghcolombia@ghcranes.com

FRANCE**GH FRANCE, SA**

ZI Le Pan Loup
Rue du Moulin de la Rousselière
44800 Saint-Herblain, France
T +33(0) 240 861 212
ghfrance@ghcranes.com

INDIA**GH CRANES INDIA PVT. LTD.**

A-3, Saket District Centre,
District Centre, Sector 6,
Pushp Vihar, Delhi Rd.,
Pune 110017, India
T +91 7030 70 5000
ghindia@ghcranes.com

**KINGDOM OF SAUDI ARABIA
INDUSTRIAS
ELECTROMECÁNICAS GH, S.A.**

Building No. 2634
Ibn Sina, King Khalid Branch Road
Al Khobar 6245 - 34627, Kingdom
of Saudi Arabia
T +966 54 2734345
gharabia@ghcranes.com

MEXICO**GRÚAS GH MEXICO SA DE CV**

Retorno 1, nº 28.
Fraccionamiento Agroindustrial
La Cruz
El Marqués 76240 Queretaro,
Mexico
T +52 44 22 77 55 03
+52 44 22 77 50 74
ghmexico@ghsa.com.mx

PERU**GH PERÚ S.A.C**

Calle Bolognesi, 125 Of. 19,
Miraflores
15074 Lima, Peru
T +51 1 734 32 99
+51 987816231
ventasghperu@ghcranes.com

POLAND**GH CRANES SP. Z O.O**

Ul. Górnicza 2b
42-100 Kłobuck, Poland
T +48 34 359 73 17
office@ghsa.pl

PORTUGAL**GH PORTUGAL**

Zona industrial do Soeiro, Lote 9
4745-399 São Mamede do
Coronado - Trofa, Portugal
T +351 229 821 688
geral@ghcranes.com

THAILAND**LGH CRANES CO., LTD**

137/4 Moo 8, Nongsak-Noenmok
Road, Nong I-run, Ban Bueng
20220 Chonburi, Thailand
T +66 (0)-2327 9399
F +66 (0)-2327-9371
ghthailand@ghcranes.com

UNITED ARAB EMIRATES**Abu Dhabi**

GH CRANE SERVICES LLC OPC
Office No - 95 Building Nasser
al Suweidi, Plot 22 Mussafah M39
P.O Box 132761
Abu Dhabi, United Arab Emirates
T +971 2 681 2671
gharabia@ghcranes.com

Dubai**GH CRANES ARABIA FZCO**

Office No. 2501, 25th Floor
Jafza One-Tower A,
Jebel Ali Free Zone.
P.O Box No, 263594
Dubai, United Arab Emirates
T +971 4 881 0773
gharabia@ghcranes.com

Ras Al Khaima**GH CRANES & COMPONENTS****FZ LLC**

Shed No. 16-17-22
Al Hamra Industrial Zone-FZ,
P.O Box 54729
Ras Al Khaima, United Arab Emirates
T +971 7 266 3648
gharabia@ghcranes.com

USA**GH CRANES & COMPONENTS****Illinois****SPARE PARTS Y COMPONENTS**

9134 Gulfstream Road
60423 Frankfort (Illinois), U.S.A.
T +1 972 563 8333
ghcranesusa@ghcranes.com

Texas**MANUFACTURE AND SERVICE**

14891 Hwy 205
75160 Terrell (Texas), U.S.A.
T +1 972 563 8333
ghcranesusa@ghcranes.com

· GH ·

CRANES & COMPONENTS

www.ghcranes.com